

Clariflo®

VAC KING



WET & DRY VACUUM CLEANERS

MODEL NO: CVAC20SS, CVAC25SSR & CVAC30SSR

PART NO: 6471105, 6471097 & 6471120

OPERATING & MAINTENANCE INSTRUCTIONS



ORIGINAL INSTRUCTIONS

GC08/23 - Rev 15

INTRODUCTION

Thank you for selecting this VAC KING Vacuum Cleaner, which will provide you with a cleaner and safer working environment.

This machine is capable of collecting both wet and dry materials as well as water. DO NOT, however, collect any other type of liquid as this could be dangerous.

Before attempting to operate the machine, it is essential that you read this manual thoroughly and carefully follow all instructions given. In doing so you will ensure the safety of yourself and that of others around you, and you can also look forward to the machine giving you long and satisfactory service.

SPECIFICATION

MODEL	CVAC20SS	CVAC25SSR	CVAC30SSR
Part No	6471105	6471097	6471120
Weight	6.5 kg	6.5 kg	8.5 kg
Dimensions (L x W x H) mm	470 x 470 x 556	338 x 330 x 490	515 x 515 x 635
Tank Capacity (water)	13 Litres	17 Litres	22 Litres
Dust Capacity	17 Litres	20 Litres	24 Litres
Max Vacuum	16.5 kPa	17 kPa	17 kPa
Max Airflow	30L/sec	28.3L/sec	32L/sec
Duty Cycle	S1 (continuous)		
Fuse Rating	13 Amps		
Power Supply	230 V/50Hz/1ph		
Motor Power rating	1.4 kW		
IP Rating	IP24	IPX4	IP24
Output Socket Rating	N/A	2200W	1400 W (6A)
Sound Pressure Level at 2m	82 dB LpA		

Please note that the details and specifications contained herein, are correct at the time of going to print. However, CLARKE International reserve the right to change specifications at any time without prior notice.

SAFETY PRECAUTIONS

WORK AREA

1. Avoid operating in the presence of flammable liquids or gases. The motor may produce sparks during operation. DO NOT use in enclosed areas where flammable, explosive or toxic vapours are given off.

PERSONAL SAFETY

1. ALWAYS stay alert, watch what you are doing and use common sense when operating the CVAC. DO NOT use the CVAC while you are tired or under the influence of medication, drugs or alcohol. A moment of inattention can result in personal injury.
2. NEVER over-reach. Keep your proper footing and balance at all times to enable better control of the machine in unexpected situations.
3. ALWAYS store the machine out of reach of children.

GENERAL MACHINE USE AND CARE

1. Prior to use, all users should become familiar with this instruction booklet.
2. ALWAYS maintain the CVAC with care and keep it clean for best / safest performance.
3. NEVER use this CVAC if any part is damaged. Have it inspected and repaired by your CLARKE dealer. DO NOT use if the electric cable, plug, or the machine itself, is in poor condition.
4. NEVER abuse the power cable. NEVER pull on the cable when removing the plug from the socket or lift the machine by the power cable. Take care not to close doors on the cable, or allow it to become snagged under furniture/objects with sharp edges. Keep away from heat or oil.
5. Only use extension leads that are of an appropriate power rating and suitable for the work environment. Extension leads must have an earth connection. Inspect the extension lead regularly and replace if damaged.
6. ALWAYS take care when a long hose is required in the work area as it presents a trip hazard. Tidy the hose away when the job is finished.
7. NEVER pick up flammable or readily combustible material such as hot ashes or coals, or use in the presence of explosive liquids or vapours.
8. NEVER pick up burning cigarettes or other smoking substances.
9. NEVER abuse the CVAC by standing on it.
10. ALWAYS transport the CVAC by lifting it by the handle.

CARE & STORAGE

1. When not in use, turn off by the On/Off switch on top of the machine, then remove the plug from the mains power supply.
2. When you have finished with the machine, ensure the electric cable is stowed away and not left as a hazard for others to trip over.
3. DO NOT change filters, or carry out any cleaning or servicing, without first disconnecting the machine from the power supply.
4. Keep the external surfaces clean. Avoid impact damage and DO NOT allow the machine to contact abrasive or corrosive materials.
5. DO NOT use solvents, thinners or alcohol to clean the CVAC, as these chemicals will damage the finish. With the machine unplugged from the power supply, use a dry cloth to wipe over the plastic casing.
6. When not in use the CVAC should be stored in a secure, dry place, out of the reach of children. DO NOT leave it exposed to the elements and avoid direct sunlight, direct heat, rain/moisture etc.
7. Only use parts and accessories recommended in this manual. The use of unauthorised accessories or attachments is not permitted and may result in personal injury or damage to the machine.
8. DO NOT attempt to repair or modify the machine. DO NOT attempt any electrical repair yourself. Consult a qualified electrician or our Service Department on 020 8988 7400.

ENVIRONMENTAL PROTECTION



By purchasing this product, the customer is taking on the obligation to deal with its safe disposal in accordance with the Waste Electrical and Electronic Equipment regulations (WEEE).

In effect, this means that this product must not be disposed of with general household waste. It must be disposed of according to the laws governing Waste Electrical and Electronic Equipment (WEEE) at a recognised disposal facility.

GUARANTEE

This CLARKE product is guaranteed against faulty manufacture for a period of 12 months from the date of purchase. Please keep your receipt as proof of purchase.

This guarantee is invalid if the product is found to have been abused or tampered with in any way, or not used for its intended purpose.

Faulty goods should be returned to their place of purchase, no product can be returned to us without prior permission. This guarantee does not effect your statutory rights.

ELECTRICAL CONNECTIONS



WARNING! READ THESE ELECTRICAL SAFETY INSTRUCTIONS THOROUGHLY BEFORE CONNECTING THE PRODUCT TO THE MAINS SUPPLY.

Before switching the product on, make sure that the voltage of your electricity supply is the same as that indicated on the rating plate. This product is designed to operate on 230VAC 50Hz. Connecting it to any other power source may cause damage.

This product may be fitted with a non-rewireable plug. If it is necessary to change the fuse in the plug, the fuse cover must be refitted. If the fuse cover becomes lost or damaged, the plug must not be used until a suitable replacement is obtained.

If the plug has to be changed because it is not suitable for your socket, or due to damage, it should be cut off and a replacement fitted, following the wiring instructions shown below. The old plug must be disposed of safely, as insertion into a mains socket could cause an electrical hazard.

CVAC20SS/CVAC25SS (DOUBLE INSULATED APPLIANCE)

NOTE: CVAC25ss has earth at the socket.

If the colours of the wires in the power cable of this product do not correspond with the markings on the terminals of your plug, proceed as follows.

- The **Blue** wire must be connected to the terminal marked **N** or coloured **Black**.
- The **Brown** must be connected to the terminal marked **L** or coloured **Red**

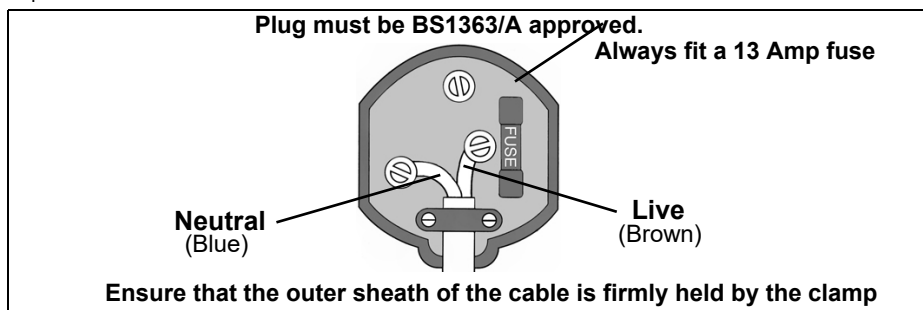

We strongly recommend that this machine is connected to the mains supply via a Residual Current Device (RCD).

CVAC30SSR (EARTHED APPLIANCE)



WARNING! THE WIRES IN THE POWER CABLE OF THIS PRODUCT ARE COLOURED IN ACCORDANCE WITH THE FOLLOWING CODE:
Blue = Neutral Brown = Live Yellow and Green = Earth

If the colours of the wires in the power cable of this product do not correspond with the markings on the terminals of your plug, proceed as follows.

- The **Blue** wire must be connected to the terminal marked **N** or coloured **Black**.
- The **Brown** wire must be connected to the terminal marked **L** or coloured **Red**.
- The **Yellow and Green** wire must be connected to the terminal marked **E** or \perp or coloured **Green**.

Plug must be BS1363/A approved.

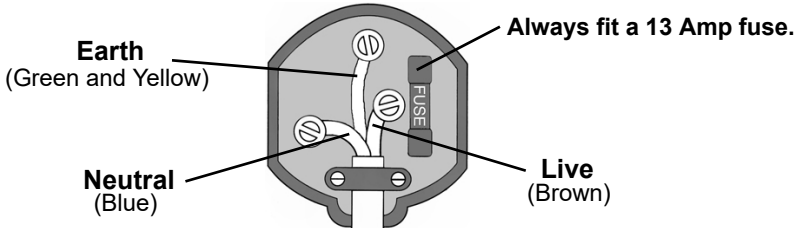

Ensure that the outer sheath of the cable is firmly held by the clamp

We strongly recommend that this machine is connected to the mains supply via a Residual Current Device (RCD).

If in any doubt, consult a qualified electrician. **DO NOT** attempt any repairs yourself.

COMPONENTS



No	Description	No	Description
1	Motor Housing & Head Section	8	Power Tool Adaptor(30SSR only)
2	Container	9	Castor
3	Flexible Hose	10	Cartridge Filter
4.	Extension Tube	11	Paper Dust Bag
5	Floor Brush Adaptor	12	Foam Filter (water pick-up only)
6	Hose/Extension Tube Angle Adaptor	13	Long nose tool (25SSR only)
7	Crevice Tool		

PREPARATION FOR USE



WARNING: BEFORE USING THE CVAC, MAKE SURE THAT YOU HAVE READ AND UNDERSTOOD THE SAFETY INSTRUCTIONS

UNPACKING & ASSEMBLY

With the CVAC removed from the packaging, undo the two clamps securing the head and remove the components from within the tank. Lay them out and check for shortages and that no damage was suffered in transit.

For ease of mobility, the CVAC base is provided with castors which require fitting. Push the four castors onto their mountings firmly.

THE FILTERS

Filters are essential to ensure that dust or foreign matter does not enter the motor compartment which would reduce motor efficiency, and eventually cause serious damage.

During dry operation, the double filtering action of the linen and paper bag filters protects the motor from dust and dirt but also ensures that the cleanest possible air is exhausted, thereby preventing dust being spread into the environment.

- A. Foam Filter
- B. Cartridge Filter
- C. Woven Cloth Bag Filter



A.



B.



C.

FOR WET USE

The foam filter is only to be used for picking up water.

It is the only filter used during this operation and must be fitted over the filter cage as shown.

The linen and paper bag filters must be removed before using the CVAC to pick up water.



FOR DRY USE

The Cartridge Filter must be fitted over the filter cage and is used when dry vacuuming ONLY.

Remove the foam filter for dry use.

The Paper Bag Filter should be used in conjunction with the Cartridge filter for dry vacuuming ONLY. It is fitted over the inlet elbow on the inside of the container. The paper bag filter will inflate in use and dust is being collected.



OPERATING INSTRUCTIONS

Before use, open the machine and check that the appropriate filters are securely in place and in good condition. If the paper bag is full, replace it. Spare bags are available from your Clarke stockist.

Switch on and start work. The CVAC should be positioned on a firm, level surface. DO NOT cover the CVAC, and always position it with good all-round ventilation. The CVAC must remain upright, especially when picking up water.

When moving the CVAC;

- ALWAYS use the handle.
- DO NOT lift by (or place a strain on) the hose or cable.
- After use always switch it off and disconnect from the power supply.

REMEMBER to use the FOAM FILTER ONLY for picking up WATER and ensure that it is correctly fitted so that it covers the filter cage completely.

NOTE: Be aware that when picking up water, the tank will gradually fill up. Check and empty at frequent intervals, otherwise the float located within the filter cage will rise and eventually shut off the suction. This is a safety feature to prevent water from coming into contact with electrical components. Should suction stop, you will hear a more urgent sound from the motor. Immediately switch OFF and empty the tank, otherwise the motor could overheat.

CVAC25SSR AND 30SSR

These machines are provided with a standard three pin auxiliary power take off which enables the machine to be used as a dust extractor for power tools. Plug the power tool into the socket and switch it on. The CVAC will automatically start. When the power tool is switched off, the CVAC will switch itself off after a short delay. Any power tool up to a maximum of 1400W/6A (2200w ON THE 25SSR) rating can be used.



A stepped adapter tube is provided which may be pushed into the dust extract port of any suitable power tool and on to which, the flexible hose may be attached.

By connecting the flexible hose to the exhaust of the CVAC, a blower function can be achieved.

ALWAYS clear the hose of any obstructions before attaching to the blower port.

WARNING: ALWAYS WEAR EYE PROTECTION TO PREVENT DEBRIS FROM BEING BLOWN OR RICOCHETING INTO THE EYES OR FACE WHICH COULD RESULT IN SERIOUS INJURY.

MAINTENANCE

Maintenance is limited to inspecting the filters and replacing if necessary. If the filters become holed or damaged they must be replaced.

The cartridge filter is of paper construction and therefore may not be washed. It may be brushed clean and compressed air set at a low pressure may also be used. The linen bag may be washed as required and dried before use.

Ensure the hose is kept in good condition. A damaged hose will seriously effect the efficiency of the machine and should be replaced immediately.

Inspect all other components periodically and replace damaged castors or accessories when necessary. Contact your CLARKE dealer for replacements.

Regular inspection and the correct maintenance of the filters will ensure efficient running and prolong the life of your machine.

ACCESSORIES

	CVAC20SS	CVAC25SSR	CVAC30SSR
CARTRIDGE FILTER	6471094		
PAPER DUST BAG FILTER	6471135	6471140	6471145
FOAM FILTER	6471092		
CASTER	TVQTJC0400		
FLEXIBLE HOSE 2.5 M	HT80819		
ANGLE ADAPTOR (HOSE TO TUBE)	HT80401		
METAL TELESCOPIC TUBE	HT80905		
COMBI BRUSH ADAPTOR TOOL	HT80701		
CREVICE TOOL	HT80707		
POWER TOOL ADAPTOR			HT80302
OPTIONAL 5M HOSE	6471155		

SPARE PARTS

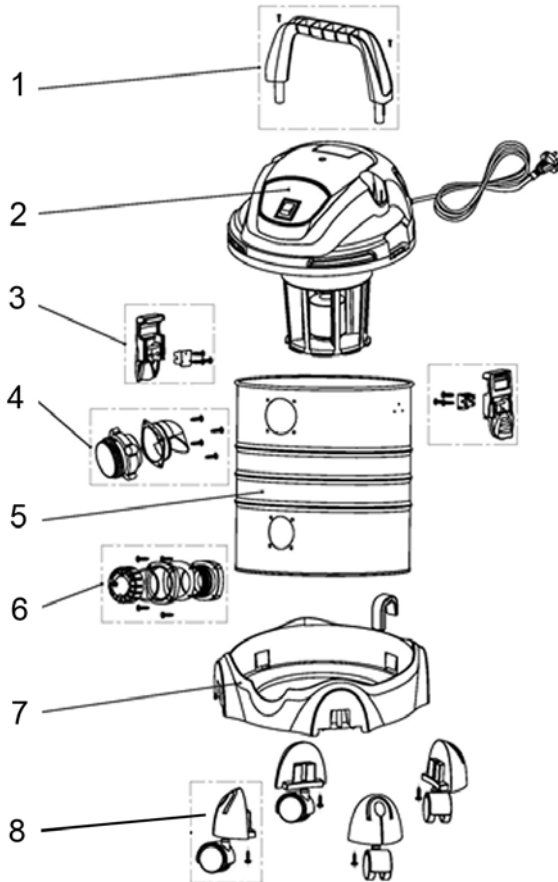

No	DESCRIPTION
1	Handle
2	Head Assembly
3	Latch Assembly
4.	Hose Inlet Assembly

No	DESCRIPTION
5	Container Body
6	Water Drain Assembly
7	Base Frame
8	Castor Assembly

DECLARATIONS OF CONFORMITY - CVAC20SS



Clarke[®]
INTERNATIONAL

Fitzwilliam Hall, Fitzwilliam Place, Dublin 2

DECLARATION OF CONFORMITY

This is an important document and should be retained.

We hereby declare that this product(s) complies with the following directive(s):

- 2014/53/EU Electromagnetic Compatibility Directive
- 2014/35/EU Low Voltage Directive
- 2011/65/EU RoHS (Restriction of Hazardous Substances) Directive

The following standards have been applied to the product(s):

- EN IEC 55014-1:2021, EN IEC 55014-2:2021, EN IEC 61000-3-2:2019/A1:2021,
- EN 61000-3-3:2013/A1:2019, EN 60335-2-2:2010/A1:2013, EN 60335-1:2012/A15:2021,
- EN 62233:2008

The technical documentation required to demonstrate that the product(s) meet(s) the requirement(s) of the aforementioned directive(s) has been compiled and is available for inspection by the relevant enforcement authorities.

The CE mark was first applied in: 2009

Product Description: Vacuum Cleaner
Model number(s): CVAC20SS
Serial / batch Number: N/A
Date of Issue: 04/01/2023

Signed:

J.A. Clarke
Director



Clarke[®]
INTERNATIONAL

Hemondill Street, Epping, Essex CM16 4JG

DECLARATION OF CONFORMITY

This is an important document and should be retained.

We hereby declare that this product(s) complies with the following statutory requirement(s):

- Electromagnetic Compatibility Regulations 2016
- Electrical Equipment (Safety) Regulations 2016
- The Restriction of the Use of Certain Hazardous Substances in Electrical and Electronic Equipment Regulations 2012

The following standards have been applied to the product(s):

- EN IEC 55014-1:2021, EN IEC 55014-2:2021, EN IEC 61000-3-2:2019/A1:2021,
- EN 61000-3-3:2013/A1:2019, EN 60335-2-2:2010/A1:2013, EN 60335-1:2012/A15:2021,
- EN 62233:2008

The technical documentation required to demonstrate that the product(s) meet(s) the requirement(s) of the aforementioned legislation has been compiled and is available for inspection by the relevant enforcement authorities.

The UKCA mark was first applied in: 2021

Product Description: Vacuum Cleaner
Model number(s): CVAC20SS
Serial / batch Number: N/A
Date of Issue: 04/01/2023

Signed:

J.A. Clarke
Director

DECLARATIONS OF CONFORMITY - CVAC25SSR





Hennell Street, Epping, Essex, CM16 4LG

Page 1 of 1

DECLARATION OF CONFORMITY

This is an important document and should be retained.

We hereby declare that this product(s) complies with the following legislation:

Electromagnetic Compatibility Regulations 2016
Electrical Equipment (Safety) Regulations 2016
The Restriction of the Use of Certain Hazardous Substances in Electrical and Electronic Equipment Regulations 2012

The following standards have been applied to the product(s):

EN IEC 55014-1:2021, EN IEC 55014-2:2021, EN IEC 61000-3-2:2019+A1:2021,
EN 61000-3-3:2015+A1:2019+A2:2021, IEC 60335-2-2:2019, EN 62233:2008,
EN 60335-1:2012+A11:2014+AC:2014+A13:2017+A1:2019+A14:2019+A2:2019+A15:2021,
IEC 62321-3-1:2013, IEC 62321-4:2017, IEC 62321-5:2013, IEC 62321-6:2015,
IEC 62321-7-1:2015, IEC 62321-7-2:2017, IEC 62321-8:2017

The technical documentation required to demonstrate that the product(s) meet(s) the requirement(s) of the aforementioned legislation has been compiled and is available for inspection by the relevant enforcement authorities.

The UKCA mark was first applied in: 2023

<p>Product Description: Vacuum Cleaner</p> <p>Model Number(s): CVAC25SSR</p> <p>Serial/Batch Number: Refer to product/packaging label</p> <p>Date of Issue: 21/04/2023</p> <p>Signed: </p>	<p>J.A. Clarke Director</p>
--	---------------------------------

CVAC25SSR UKCA Clarke DOC 042123





Fitzwilliam Hall, Fitzwilliam Place, Dublin 2

Page 1 of 1

DECLARATION OF CONFORMITY

This is an important document and should be retained.

We hereby declare that this product(s) complies with the following legislation:

Electromagnetic Compatibility Directive
2014/53/EU
Low Voltage Directive
2011/65/EU
Restriction of the Use of Certain Hazardous Substances in Electrical and Electronic Equipment (RoHS) Directive

The following standards have been applied to the product(s):

EN IEC 55014-1:2021, EN IEC 55014-2:2021, EN IEC 61000-3-2:2019+A1:2021,
EN 61000-3-3:2013+A1:2019+A2:2021, IEC 60335-2-2:2019, EN 62233:2008,
EN 60335-1:2012+A11:2014+AC:2014+A13:2017+A1:2019+A14:2019+A2:2019+A15:2021,
IEC 62321-3-1:2013, IEC 62321-4:2017, IEC 62321-5:2013, IEC 62321-6:2015,
IEC 62321-7-1:2015, IEC 62321-7-2:2017, IEC 62321-8:2017

The technical documentation required to demonstrate that the product(s) meet(s) the requirement(s) of the aforementioned legislation has been compiled and is available for inspection by the relevant enforcement authorities.

The CE mark was first applied in: 2023

<p>Product Description: Vacuum Cleaner</p> <p>Model Number(s): CVAC25SSR</p> <p>Serial/Batch Number: Refer to product/packaging label</p> <p>Date of Issue: 21/04/2023</p> <p>Signed: </p>	<p>J.A. Clarke Director</p>
--	---------------------------------

CVAC25SSR CE Clarke DOC 042123

DECLARATION OF CONFORMITY - CVAC30SSR



Fitzwilliam Hall, Fitzwilliam Place, Dublin 2

DECLARATION OF CONFORMITY

This is an important document and should be retained.

We hereby declare that this product(s) complies with the following legislation:

- 2014/53/EU Electromagnetic Compatibility Directive
- 2014/35/EU Low Voltage Directive
- 2011/65/EU Restriction of the Use of Certain Hazardous Substances in Electrical and Electronic Equipment (RoHS) Directive

The following standards have been applied to the product(s):

- EN IEC 55014-1-2:2021, EN IEC 55014-2-2:2021, EN IEC 61000-3-2:2019/A1:2021,
- EN 61000-3-3:2013/A2:2021, EN 60335-1:2012/A15:2021, EN 60335-2-2:2010/A1:2013,
- EN 62233:2008

The technical documentation required to demonstrate that the product(s) meet(s) the requirement(s) of the aforementioned legislation has been compiled and is available for inspection by the relevant enforcement authorities.

The CE mark was first applied in: 2009

Product Description: Vacuum Cleaner
 Model Number(s): CVAC30SSR
 Serial/Batch Number: Refer to product/packaging label
 Date of Issue: 20/01/2023

Signed:

J.A. Clarke
Director



Hemmall Street, Epping, Essex, CM16 4LG

DECLARATION OF CONFORMITY

This is an important document and should be retained.

We hereby declare that this product(s) complies with the following legislation:

- Electromagnetic Compatibility Regulations 2016
- Electrical Equipment (Safety) Regulations 2016
- The Restriction of the Use of Certain Hazardous Substances in Electrical and Electronic Equipment Regulations 2012

The following standards have been applied to the product(s):

- EN IEC 55014-1-2:2021, EN IEC 55014-2-2:2021, EN IEC 61000-3-2:2019/A1:2021,
- EN 61000-3-3:2013/A2:2021, EN 60335-1:2012/A15:2021, EN 60335-2-2:2010/A1:2013,
- EN 62233:2008

The technical documentation required to demonstrate that the product(s) meet(s) the requirement(s) of the aforementioned legislation has been compiled and is available for inspection by the relevant enforcement authorities.

The UKCA mark was first applied in: 2021

Product Description: Vacuum Cleaner
 Model Number(s): CVAC30SSR
 Serial/Batch Number: Refer to product/packaging label
 Date of Issue: 20/01/2023

Signed:

J.A. Clarke
Director

A SELECTION FROM THE VAST RANGE OF

Clarke®

QUALITY PRODUCTS



AIR COMPRESSORS

From DIY to industrial, Plus air tools, spray guns and accessories.

GENERATORS

Prime duty or emergency standby for business, home and leisure.

POWER WASHERS

Hot and cold, electric and engine driven - we have what you need

WELDERS

Mig, Arc, Tig and Spot. From DIY to auto/industrial.

METALWORKING

Drills, grinders and saws for DIY and professional use.

WOODWORKING

Saws, sanders, lathes, mortisers and dust extraction.

HYDRAULICS

Cranes, body repair kits, transmission jacks for all types of workshop use.

WATER PUMPS

Submersible, electric and engine driven for DIY, agriculture and industry.

POWER TOOLS

Angle grinders, cordless drill sets, saws and sanders.

STARTERS/CHARGERS

All sizes for car and commercial use.



PARTS & SERVICE: 0208 988 7400

Parts Enquiries
Parts@clarkeinternational.com

Servicing & Technical Enquiries
Service@clarkeinternational.com

SALES: UK 01992 565333 or Export 00 44 (0)1992 565335

Clarke INTERNATIONAL Hemnall Street, Epping, Essex CM16 4LG
www.clarkeinternational.com